



katalog náhradních dílů
automatického kotle
KP08

PONAST spol. s r.o
Na Potůčkách 163
757 01 Valašské Meziříčí
ČESKÁ REPUBLIKA
tel.: 571 688111*
e-mail: ponast@ponast.cz

aktualizace: 05/12/2018



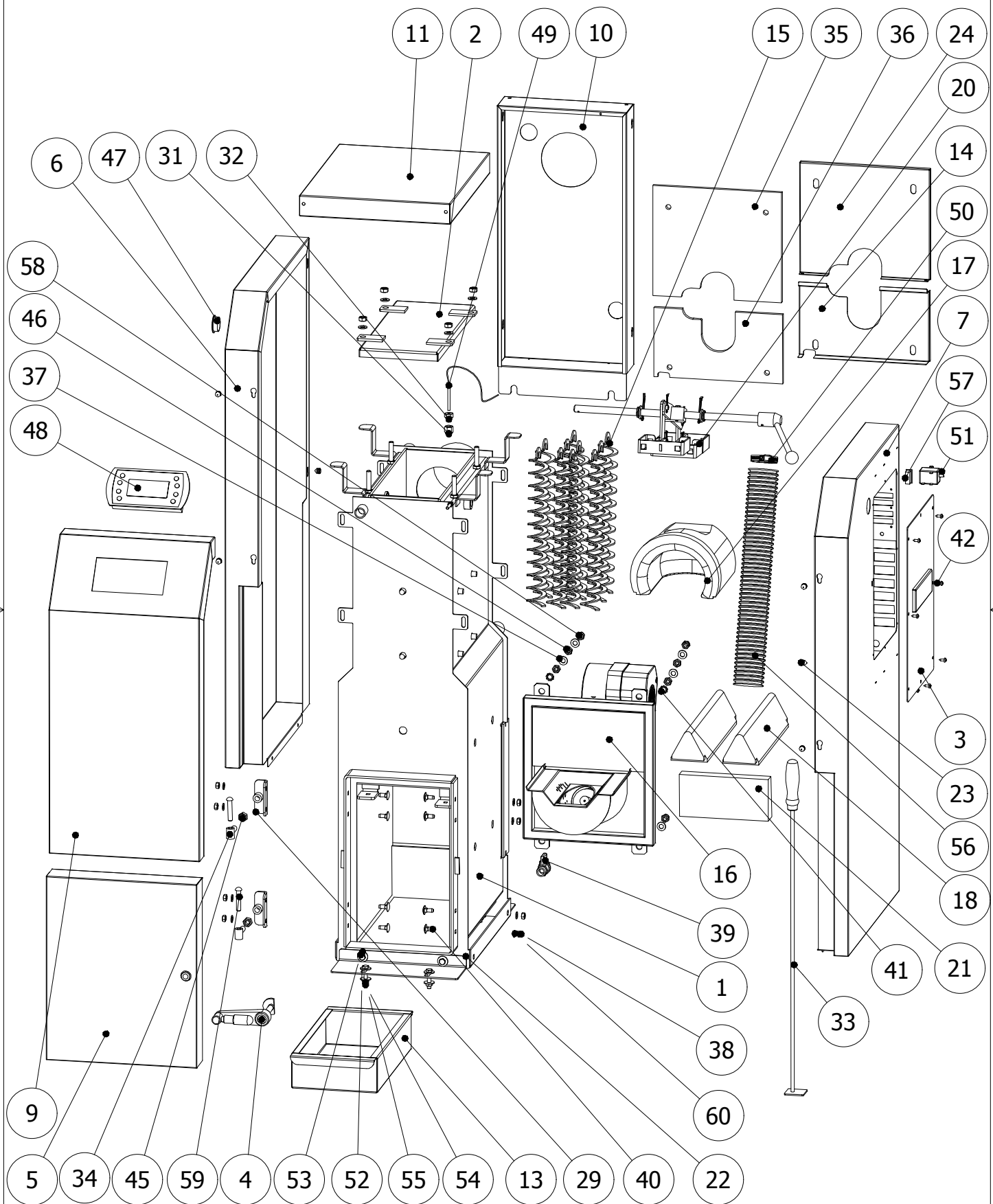

KOTEL KP08





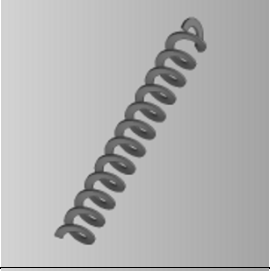

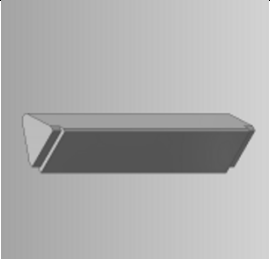
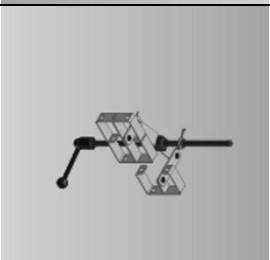
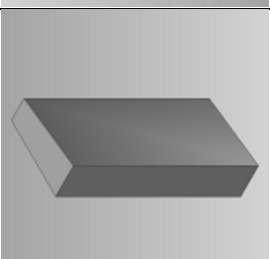
KOTEL KP08	POZICE	POPIS	KÓD	ČÍSLO SOUČÁSTI	POČET KS	POZNÁMKY
	1	TĚLESO KOTLOVÉ KP08	PKXX0801	757.S01.000.A1	1	
	2	VÍKO KP08	KKTX0065	757.S02.000.A2	1	Sestava
	3	KRYT Ř.J.	PKMD0273	757.015.000.A3	1	ESTYMA
	4	KLIKA x2	KKTX0019	338.S04.000.A3	1	Sestava
	5	DVÍŘKA KP08	KKTX0066	757.005.000.A3	1	Sestava
	6	BOČNICE LEVÁ PKMD0260 PKMD0318	PKMD0260 PKMD0318	757.S06.000.A3	1	PRAVÝ K. LEVÝ K.

KOTEL KP08	POZICE	POPIS	KÓD	ČÍSLO SOUČÁSTI	POČET KS	POZNÁMKY
	7	BOČNICE PRAVÁ	PKMD0263 PKMD0319	757.S07.000.A3	1	PRAVÝ K. LEVÝ K.
	9	KRYT PŘEDNÍ	PKMBB0268	757.S09.000.A3	1	ESTYMA
	10	DÍL ZADNÍ	PKMD0269	757.010.000.A2	1	
	11	KRYT HORNÍ	PKMBB0271	757.S11.000.A3	1	
	13	POPELNÍK KP08	PKTX0392	757.013.000.A3	1	
	14	KRYT HOŘÁKU 2	PKMD0266	757.008.000.A3	1	

KOTEL KP08	POZICE	POPIS	KÓD	ČÍSLO SOUČÁSTI	POČET KS	POZNÁMKY
	15	TURBULÁTOR PLOCHÝ 352mm	MRUZ0265	757.014.000.A4	10	
	16	HOŘÁK KP08 DKM_MK04	KHXX0801	774.000.000.A3	1	Sestava
	17	REFLEKTOR KERAMICKÝ	MTKE0020	001.042.000.A3	1	
	18	KERAMIKA TROJÚHELNÍKOVÁ KP08	MTKE0022	757.900.000.A3	2	
	20	ČISTĚNÍ VÝMĚNÍKU KP08	KKTX0067	770.000.000.A3	1	Sestava
	21	KERAMIKA NAD DVÍŘKA KP11	MTKE0005	056.021.000.A4	1	

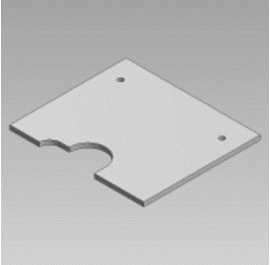
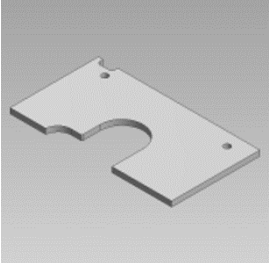

KOTEL KP08	POZICE	POPIS	KÓD	ČÍSLO SOUČÁSTI	POČET KS	POZNÁMKY
	22	DRŽÁK 2		757.000.501.A3	2	
	23	KLÍČ	PKRX0008	286.000.000.A4	8	
	24	KRYT HOŘÁKU	PKMD0274	757.024.000.A3	1	
	29	PANT DÍL 2	PKTX0134	397.S01.S43.A3	2	
	31	REDUKCE DÍL 1	PKRX0062	792.001.000.A4	1	
	32	REDUKCE DÍL 2	PKRX0063	792.002.000.A4	1	

KOTEL KP08	POZICE	POPIS	KÓD	ČÍSLO SOUČÁSTI	POČET KS	POZNÁMKY
	33	ŠKRABKA	PKRX0001	001.S32.000.A4	1	
	34	PANT DVÍŘEK	PKTX0121	054.S05.S03.A4	2	
	35	SIBRAL 10x264x304	MTIZ0027	757.044.000.A4	1	
	36	SIBRAL 10x166x304	MTIZ0026	757.043.000.A4	1	
	37	Ploché podložky - 10	MSPX0005	ISO 7089	12	
	38	Šestihranné matice - M8	MSMX0016	ISO 4032	12	

KOTEL KP08	POZICE	POPIS	KÓD	ČÍSLO SOUČÁSTI	POČET KS	POZNÁMKY
	39	VENTIL VYPOŠTĚCÍ S PÁČKOU	MRUZ0024		1	
	40	Šroub s půlk. hl.a 4hr.kr. - M8 x 20	MSSX0207	DIN 603	8	
	41	Vějířová pojistná podložka - A 10,5	MSPX0003	DIN 6797	2	
	42	Šrouby samořezné - ST 4,8 x 13	MSSX0118	ISO 7049	8	
	45	Šestihranné matice - M12	MSMX0007	ISO 4032	2	
	46	Šestihranné matice - M10	MSMX0041	ISO 4032	10	



KOTEL KP08	POZICE	POPIS	KÓD	ČÍSLO SOUČÁSTI	POČET KS	POZNÁMKY
	47	ZÁSLEPKA ČERNÁ 35-38mm	MRUZ0228		1	ČERNÁ
	48	PANEL IGNEO SLIM ESTYMA NEGATIV	METRO204		1	
	49	Snímač teploty TR 050J-x TCK, 1,4m	METRO108		1	
	50	SPONA HADICOVÁ 60-80 Zn	MRUZ0268		1	
	51	HAVARIJNÍ TERMOSTAT LY 26 I	METRO049		1	
	52	Podložka - 8,4	MSPX0008	DIN 9021	12	

KOTEL KP08	POZICE	POPIS	KÓD	ČÍSLO SOUČÁSTI	POČET KS	POZNÁMKY
	53	Šestihranný šroub - M8 x 20	MSSX0002	DIN 933	4	
	54	Šestihranný šroub - M8 x 40	MSSX0027	DIN 933	4	
	55	Šestihranná matice - M8	MSMX0016	DIN 934	4	
	56	HADICE FLEXADUR PU-1NO DN 80x1000	MRUZ0121		1	
	57	Vypínač SSk 315 RED	MERX0579		1	
	58	Šestihranná matice uzavřená - M10	MSMX0018	DIN 1587	4	

KOTEL KP08	POZICE	POPIS	KÓD	ČÍSLO SOUČÁSTI	POČET KS	POZNÁMKY
	59	NÝT 10x50 Fe	MSRX0032	DIN 660	2	
	60	Ploché podložky - 8	MSPX0001	ISO 7089	12	

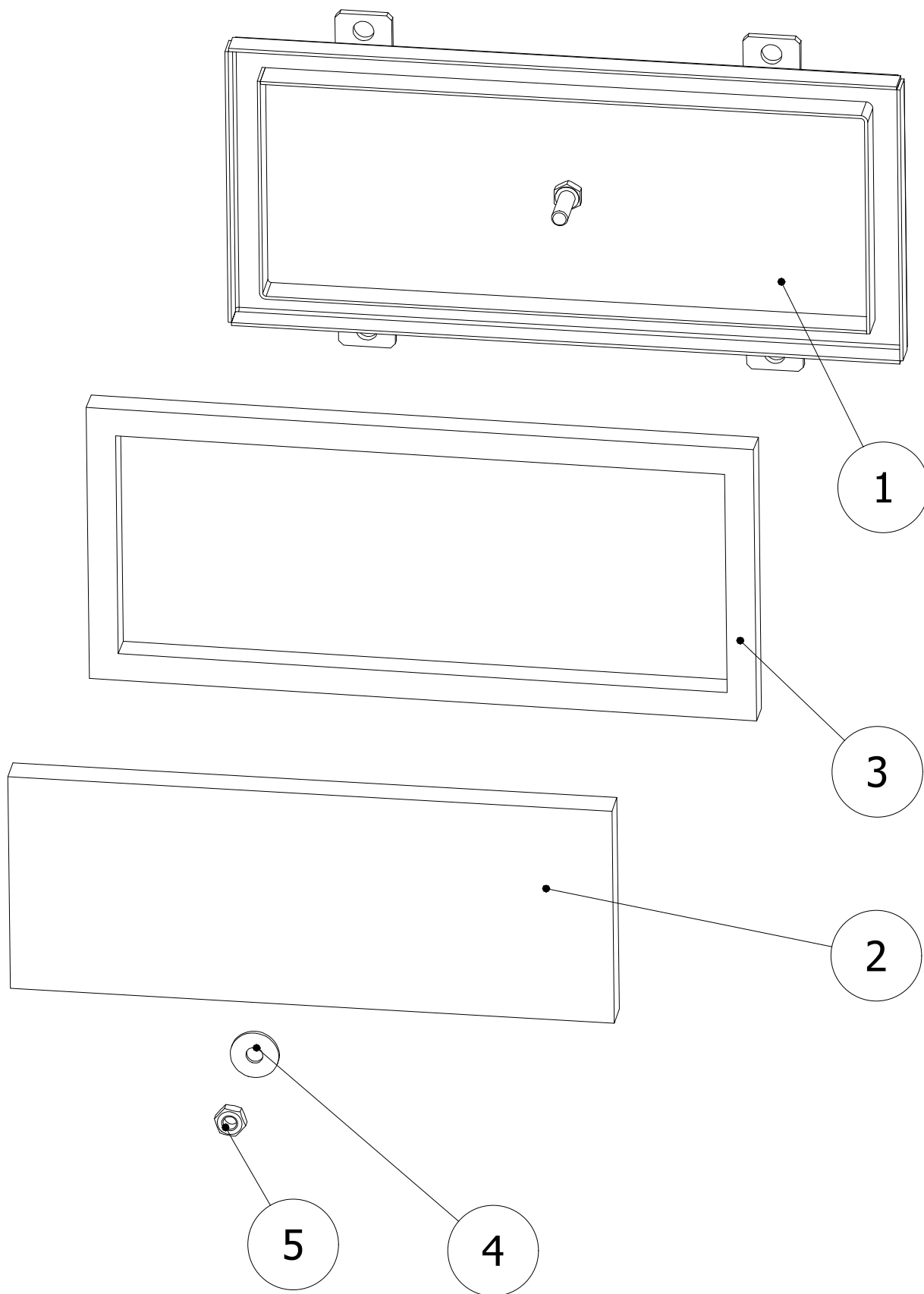

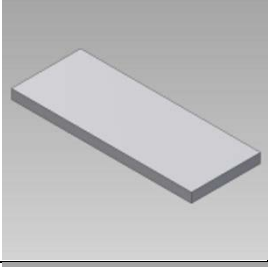
VÍKO

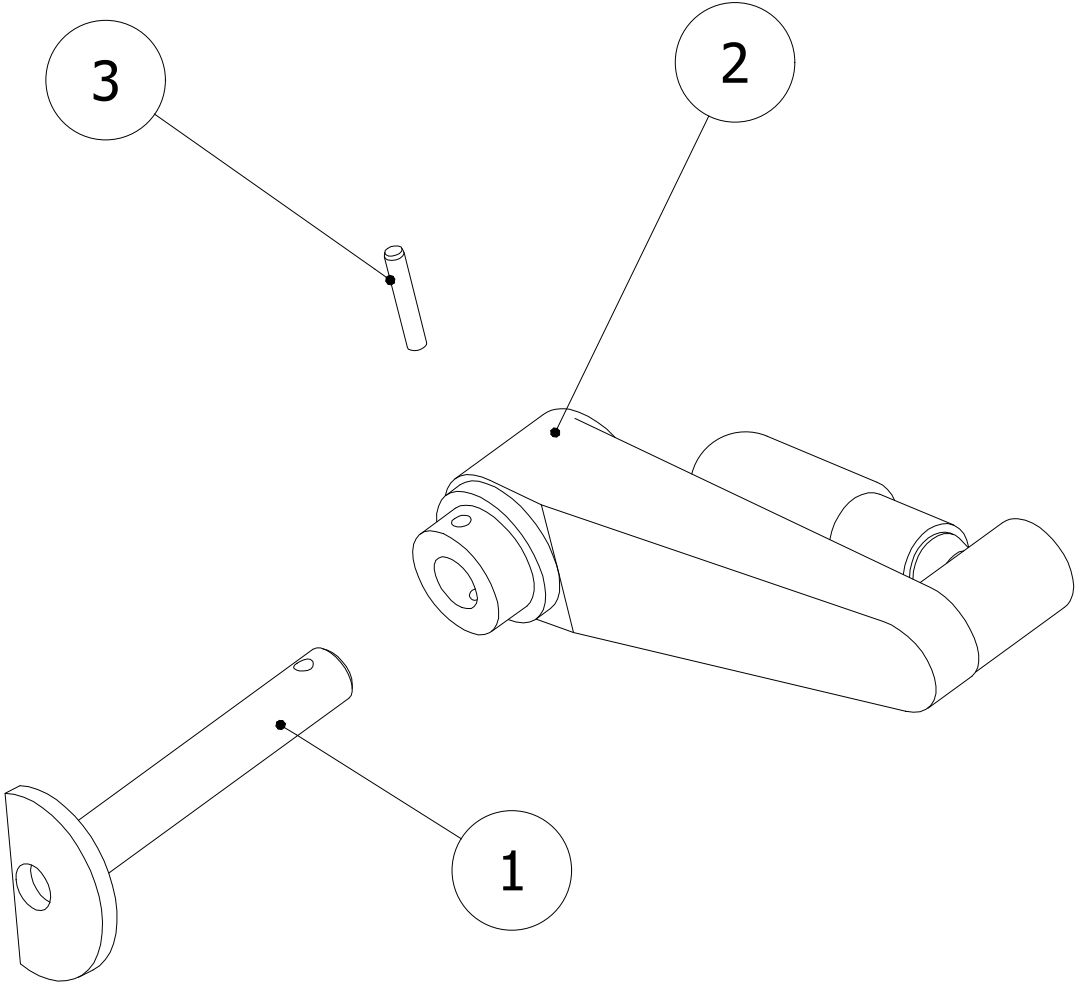

VÍKO KP08	POZICE	POPIS	KÓD	ČÍSLO SOUČÁSTI	POČET KS	POZNÁMKY
	1	VÍKO-SVAŘENEC KP08	PKTX0393	757.S02.S00.A3	1	
	2	SIBREX 140 20x143x37 3	MTIZ0025		1	
	3	ŠŇŮRA TĚSNÍCÍ 18x18	MRUZ0133		1.29m	
	4	Podložka - 10,5	MSPX0004	DIN 9021	1	
	5	Šestihranná matice - M10	MSMX000 2	DIN 934	1	

KLIKA

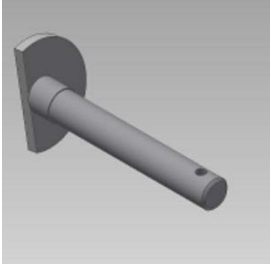

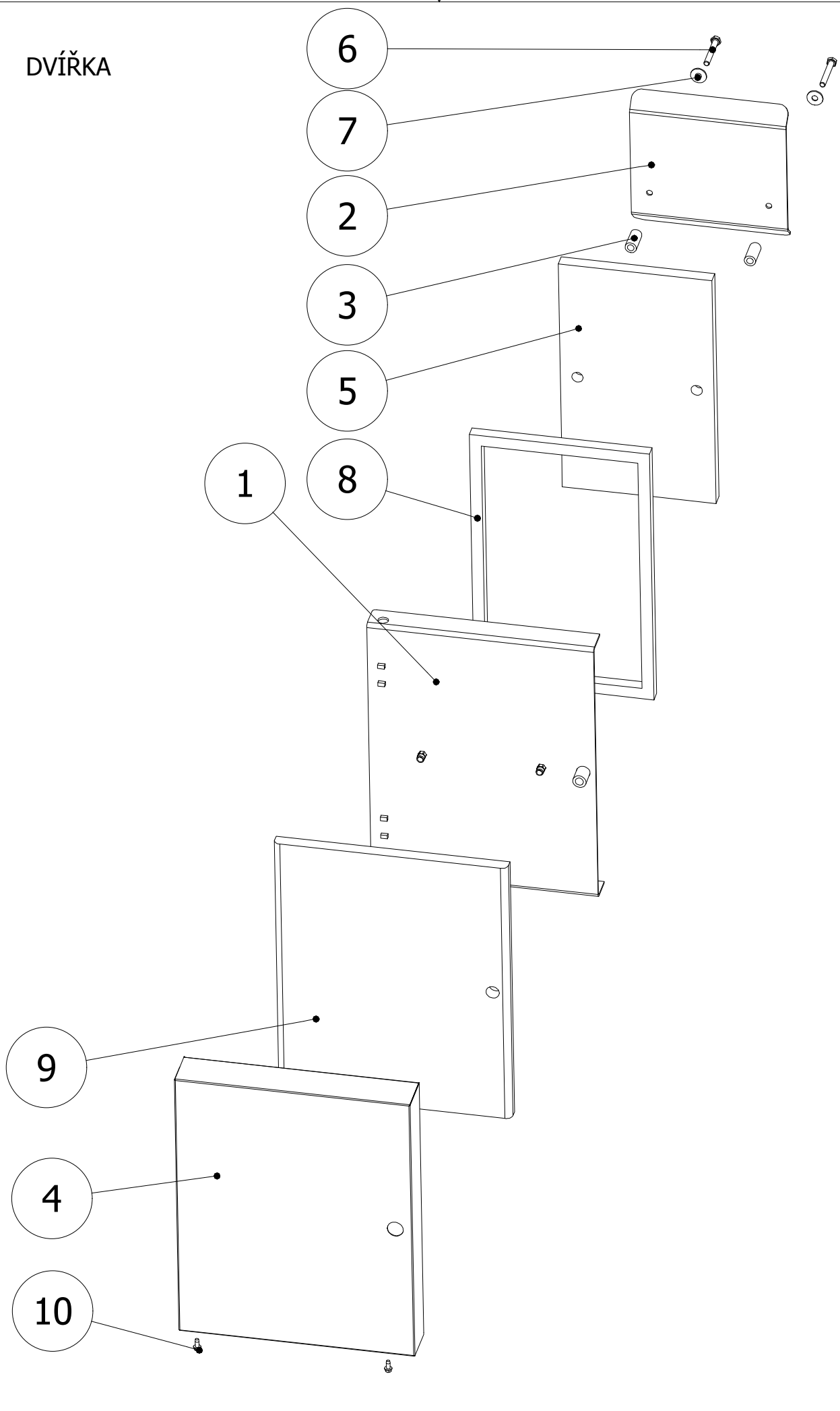

KLIIKA	POZICE	POPIS	KÓD	ČÍSLO SOUČÁSTI	POČET KS	POZNÁMKY
	1	DŘÍK KLIKY	PKTX0118	054.S04.001.A3	1	
	2	KLIIKA SKLAPOVACÍ ELESA GANTER	MRUZ0117	MT.100-AT+IR	1	KÓD 44317
	3	Kolík - 4 x 24 - A (kalený)	MSRX0003	ISO 8734	1	

DVÍŘKA



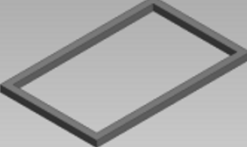
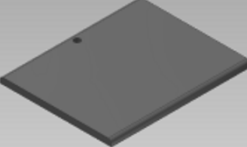



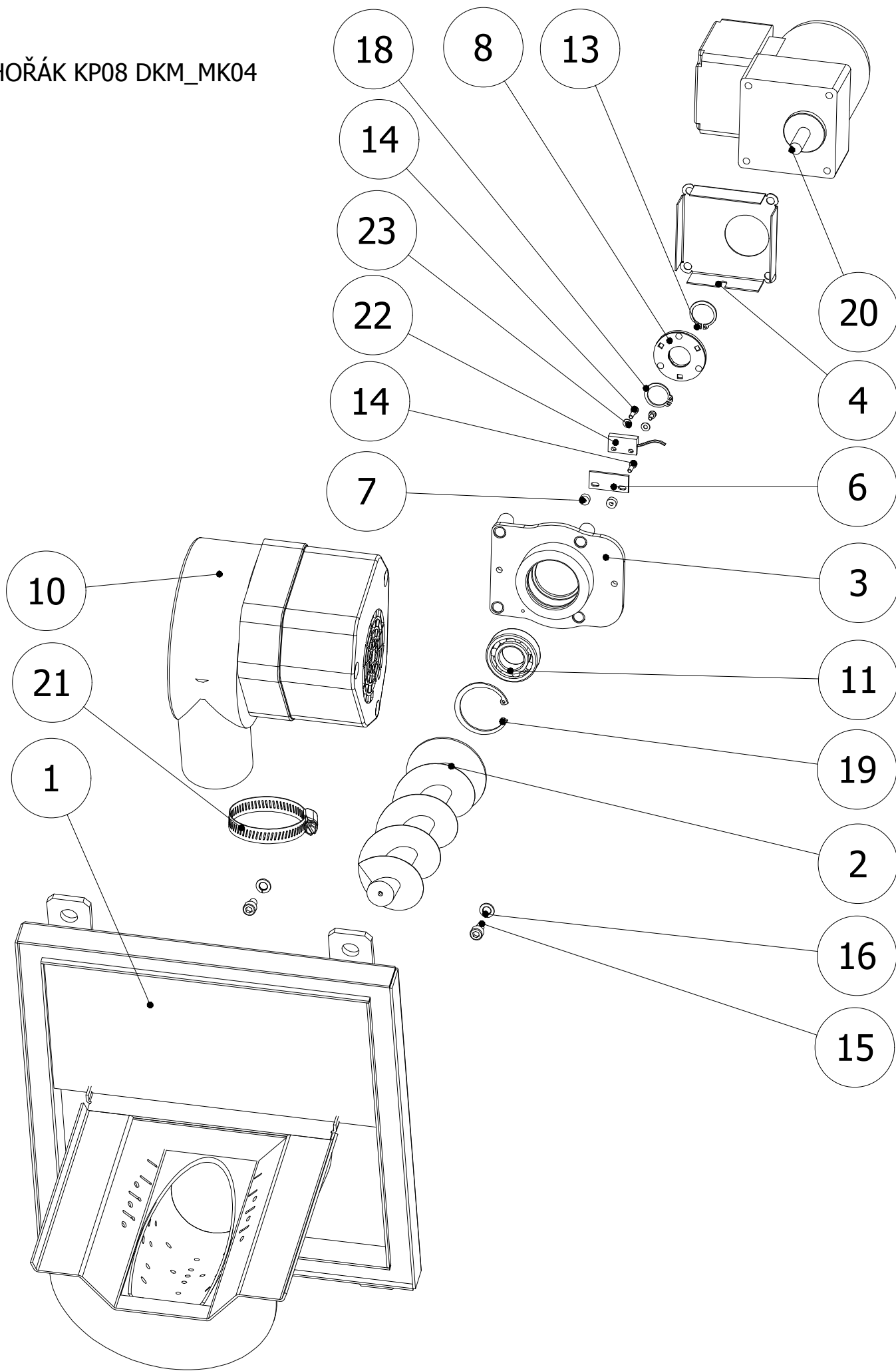

DVÍŘKA KP08	POZICE	POPIS	KÓD	ČÍSLO SOUČÁSTI	POČET KS	POZNÁMKY
	1	DVÍŘKA SVAŘENEC KP08	PKTX0396	757.S05.000.A3	1	
	2	ŠTÍT	PKTX0401	757.005.001.A3	1	
	3	DISTANCE	PKTX0402	757.005.002.A4	2	
	4	KRYT DVÍŘEK	PKMBB02 72	757.012.000.A3	1	
	5	SIBREX 300 20x233x38 7	MTIZ0004		1	
	6	Šestihranný šroub - M8 x 60	MSSX022 3	ISO 4017	2	

DVÍŘKA KP08	POZICE	POPIS	KÓD	ČÍSLO SOUČÁSTI	POČET KS	POZNÁMKY
	7	Ploché podložky – 8	MSPX000 8	ISO 7093 C HV	2	
	8	ŠŤŮRA TĚSNÍCÍ 18x18	MRUZ013 3		1.35m	
	9	IZOLACE DVÍŘEK KP08 20x353x43 9	MTIZ0011		1	
	10	Tex 4,8x16 mm	MSSX004 7		2	

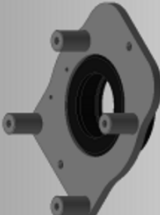
HOŘÁK KP08 DKM_MK04



HOŘÁK KP08	POZICE	POPIS	KÓD	ČÍSLO SOUČÁSTI	POČET KS	POZNÁMKY
	1	HOŘÁK KP08 RAVEO+TĚSNĚNÍ+SIBREX	KHXX0802	774.S00.000.A3	1	Sestava
	2	ŠNEK KP08	PHXX0178	647.S06.000.A3	1	Délka 269mm
	3	DOMEČEK	PHXD0181	647.S10.000.A4	1	
	4	KRYT SNÍMAČE OTÁČEK	MHVL0192	731.006.000.A3	1	
	5	TĚSNĚNÍ	PHXX0115	493.021.000.A4	1	
	6	Adaptér pro MK04	PHXX0214	798.110.001.A4	1	

HOŘÁK KP08	POZICE	POPIS	KÓD	ČÍSLO SOUČÁSTI	POČET KS	POZNÁMKY
	7	PODLOŽKA SNÍMAČE MEDER	PHXX0163	428.500.000.A4	2	
	8	KOLO SNÍMAČE MEDER MK04/RAVEO	PHXX0210	PHXX0210	1	
	9	Spirála zapalovací 500W	MERX0011		1	
	10	VENTILÁTOR RLG 97	MEVE0005		1	
	11	Ložiska - ZKL 6004A	MRUZ0511	CSN 024630 ZKL	1	
	12	Ploché podložky - 6	MSPX0026	ISO 7089	3	

HOŘÁK KP08	POZICE	POPIS	KÓD	ČÍSLO SOUČÁSTI	POČET KS	POZNÁMKY
	13	Pojistné kroužky pro hřídele	MSRX0089	DIN 471	1	
	14	Šroub s válcovou hlavou - M3 x 12	MSSX0131	DIN 912	2	
	15	Šroub s válcovou hlavou - M6 x 10	MSSX0127	DIN 912	2	
	16	Pružná podložka - A6	MSPX0019	DIN 128	2	
	17	Šestihranný šroub - M6 x 16	MSSX0015	DIN 933	3	
	18	Pojistné kroužky pro hřídele - 18x1,2	MSRX0098	DIN 471	1	

HOŘÁK KP08	POZICE	POPIS	KÓD	ČÍSLO SOUČÁSTI	POČET KS	POZNÁMKY
	19	Pružný pojistný kroužek - 42 x 1,75	MSRX0094	DIN 472	1	
	20	DKM MOTOR 8RDGE-25G-T-8GBK90BMH	MEMP0038		1	
	21	SPONA HADICOVÁ 50-70 Zn	MRUZ0131		1	
	22	Snímač MEDER MK04-1A66-dl. 1900mm	MERX0777		1	
	23	Ploché podložky - 3	MSPX0031	ISO 7089	2	
	24	Šroub s válcovou hlavou - M3 x 6	MSSX0226	DIN 912	1	

HOŘÁK KP08 RAVEO+TĚSNĚNÍ+SIBREX

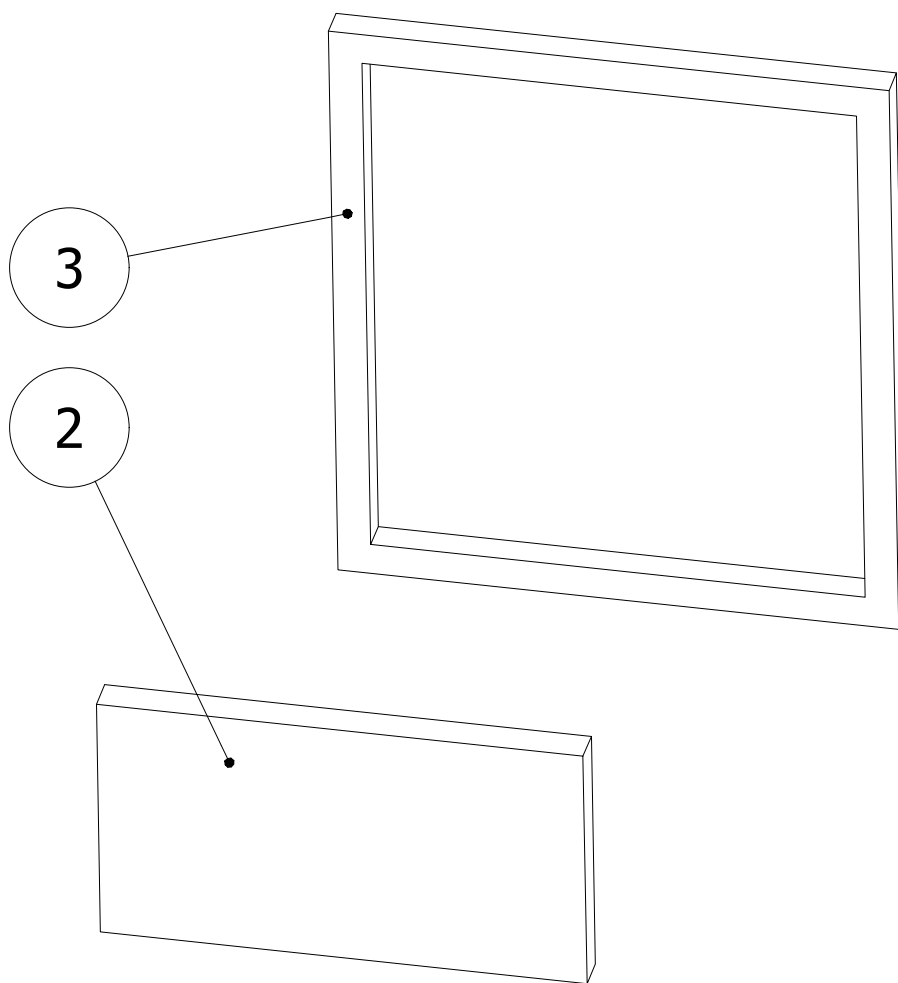
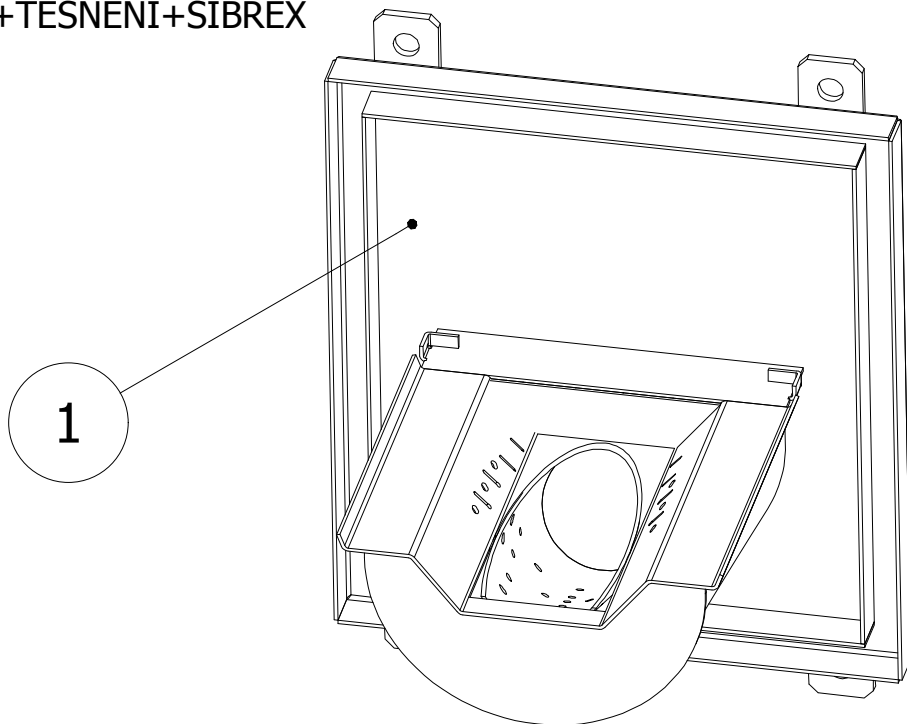

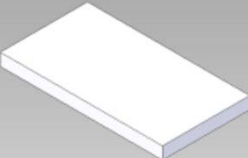
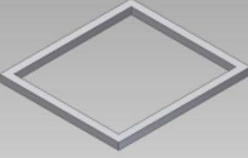
HOŘÁK KP08 RAVEO+TĚSNĚNÍ+SIBREX	POZICE	POPIS	KÓD	ČÍSLO SOUČÁSTI	POČET KS	POZNÁMKY
	1	HOŘÁK KP08 SVAŘENEC	PHXX0801	774.S01.000.A3	1	
	2	DESKA 20x260x14 2	MTIZ0003		1	
	3	ŠŇŮRA TĚSNÍCÍ 18x18	MRUZ013 3		1.26m	

ČISTĚNÍ VÝMĚNÍKU KP08

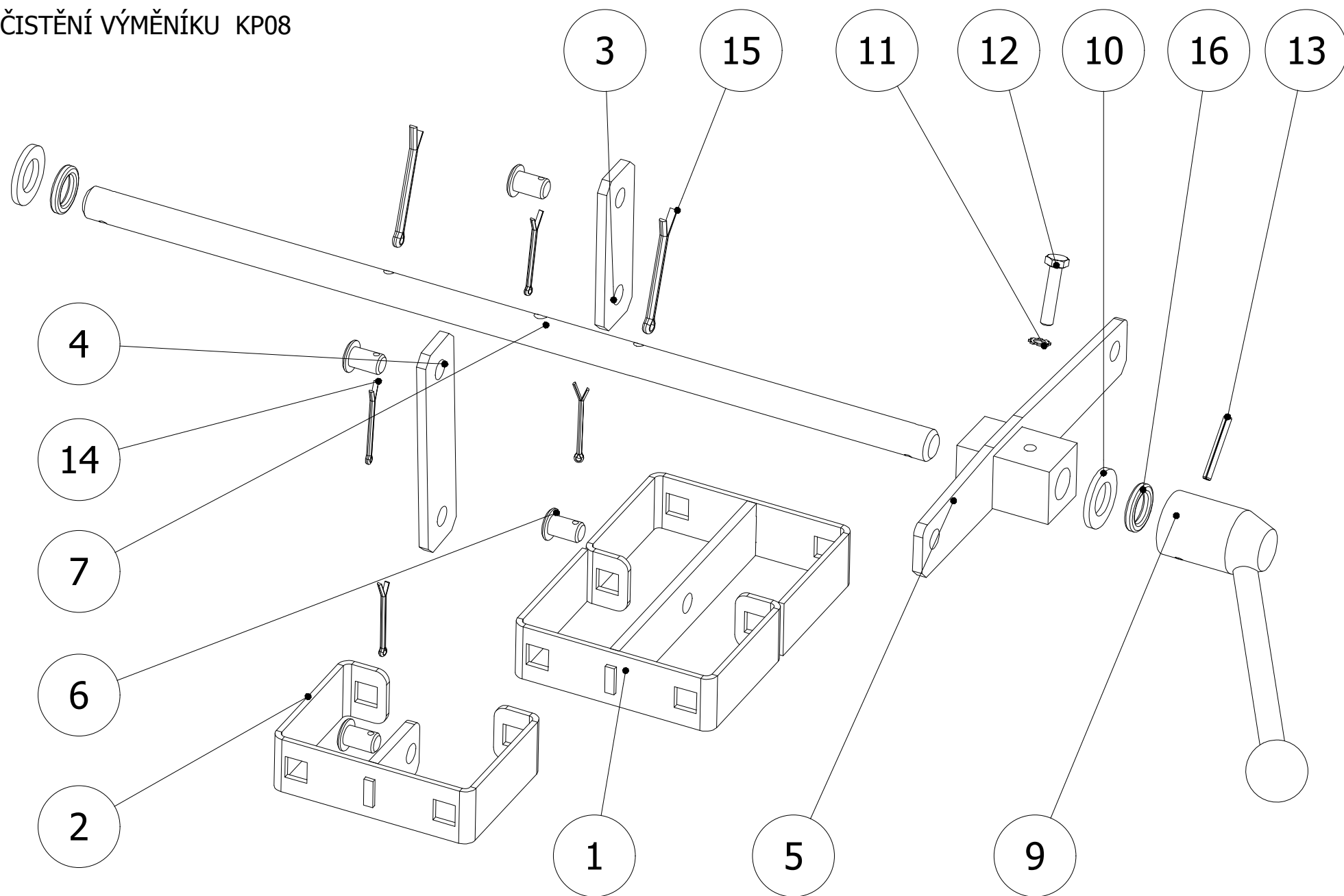

ČISTĚNÍ VÝMĚNÍKU KP08	POZICE	POPIS	KÓD	ČÍSLO SOUČÁSTI	POČET KS	POZNÁMKY
	1	VAHADLO 1	PKTX0403	770.S01.000.A4	1	
	2	VAHADLO 2	PKTX0406	770.S02.000.A3	1	
	3	ZÁVĚS 2	PKTX0409	770.003.000.A4	1	
	4	ZÁVĚS	PKTX0410	770.004.000.A4	1	
	5	TÁHLO 2	PKTX0411	770.S05.000.A4	1	
	6	ČEP	PKTX0053	005.S16.007.A4	4	

ČISTĚNÍ VÝMĚNÍKU KP08	POZICE	POPIS	KÓD	ČÍSLO SOUČÁSTI	POČET KS	POZNÁMKY
	7	HŘÍDEL ČISTĚNÍ	PKTX0413	770.007.000.A4	1	
	9	PÁKA UPÍNACÍ	MRUZ0222	GN 212-32- B16-C	1	
	10	Podložka - A 17	MSPX0030	DIN 125	2	
	11	Vějířová pojistná podložka- A 6,4	MSPX0012	DIN 6797	1	
	12	Šestihranný šroub - M6 x 30	MSSX0008	ISO 4017	1	
	13	Pružné přímé kolíky - 4 x 30	MSRX0090	ISO 8752	1	

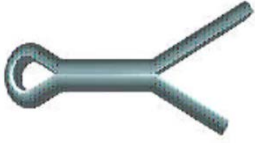
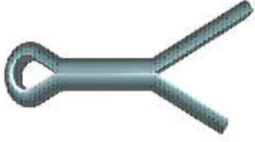
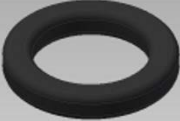
ČISTĚNÍ VÝMĚNÍKU KP08	POZICE	POPIS	KÓD	ČÍSLO SOUČÁSTI	POČET KS	POZNÁMKY
	14	Závlačka - 2,5 x 36	MSRX0048	ISO 1234	4	
	15	Závlačka - 4 x 50	MSRX0021	ISO 1234	2	
	16	Šňůra těs. čistění 4x4	PKTX0432		2	

ELEKTRO

KÓD	POPIS	MNOŽSTVÍ
KKEX0002	Rámečky ENSTO KP 08	1,0 ks
MERX0007	Relé VS 116K	1,0 ks
MERX0008	Mústek SP15/Z propojovací	1,0 ks
MERX0010	Pásek vázací 200/2.5	5,0 ks
MERX0032	Pásek vázací 100/2,5	4,0 ks
MERX0051	Vývodka PG 9 s matkou	3,0 ks
MERX0067	Přichytka PKB-BS 27x27mm přírodní samolepící	1,0 ks
MERX0078	Štítek uzemění malý /baleno po 40 ks/	5,0 ks
MERX0223	Páska Izol. 15Mm/10Mpvc bílá	2,0 ks
MERX0556	Šňůra FLEXO 3m H05VV-F3x1,5	1,0 ks
MERX0645	Svorka PAKL 140 přístr. pr. 1- 4mm	0,2 ks
MERX0668	Filtr odrušovací FK 2-10-230/DIN	1,0 ks
MERX0670	Lišta TS 35Dx7,5/030	1,0 ks
METR0053	Zástrčka 2PIN AK950/2	8,0 ks
METR0081	Kabel propoj. K-PFL20-40	1,0 ks
METR0094	Vidlice kabel. NAC41S.B černá ENSTO	1,0 ks
METR0103	Vidlice kabel. NBC31S.S modrá ENSTO	2,0 ks
METR0105	Vidlice kabel. NCC31S.P červená ENSTO	1,0 ks
METR0143	Svorkovnice čidel Codaco	1,0 ks
MREZ0012	Etiketa stříbrná 210x297 baleno po 20 ks	1,0 ks
MRUZ0021	Štítek logo PONAŠT	1,0 ks
MRUZ0081	Těsnění 9x4 šedé PE/100m	0,3 m
MRUZ0219	Průchodka 24,9 x 1,6 Moss 11214	1,0 ks
MRUZ0267	Manostat tlaku vzduchu 17-75 Pa univerzální	1,0 ks
MRUZ0272	Zátka antivibrační 1/2 BSP - velikost 8	1,0 ks
MRUZ0273	Zátka antivibrační 3/4" BSP (SIZE12)	2,0 ks
MRUZ0276	Samolepka KP08	1,0 ks
MTBX0033	Páska oboustranně lepící š.=15mm	0,25 ks
PKEX0040	ESTYMA - základ kotle	1,0 ks
PKEX0041	Spoj.mater. Svorkovnice Codaco	1,0 ks
PKEX0047	Kabeláž Estyma SVAZEK_1, 2, 3	1,0 ks
PKEX0057	Kabely P1,P2,Vent,Estyma 11,21,12,08 s DKM 2016	1,0 ks

PONAST spol. s r.o
Na Potůčkách 163
757 01 Valašské Meziříčí

ČESKÁ REPUBLIKA

www.ponast.cz

tel.: 571 688 111*, 800 700 068

e-mail: servis@ponast.cz