



**katalog náhradních dílů**  
**automatického kotle**  
**KP 21**

PONAST spol. s r.o  
Na Potůčkách 163  
757 01 Valašské Meziříčí  
ČESKÁ REPUBLIKA  
tel.: 571 688111\*  
e-mail: ponast@ponast.cz

aktualizace: 07/12/2018





KOTEL KP21

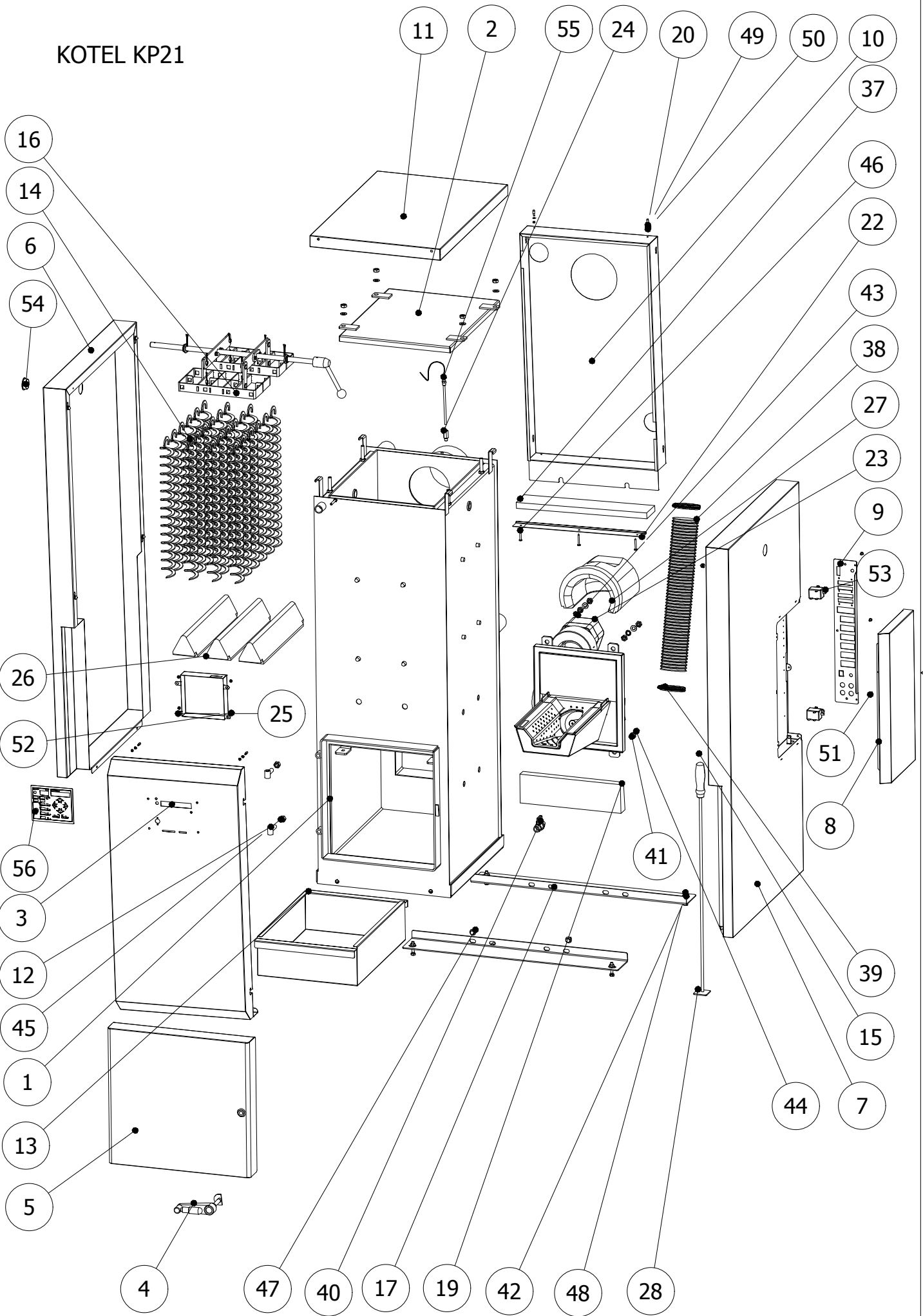





KOTEL KP21	POZICE	POPIS	KÓD	ČÍSLO SOUČÁSTI	POČET KS	POZNÁMKY
	1	TĚLESO KOTLOVÉ	PKXX2101	054.S01.000.A1	1	Sestava
	2	VÍKO KOTL.TĚLESA KP20,21	KKTX0007	001.S02.000.A2	1	Sestava
	3	KRYT PŘEDNÍ	PKMXD186	756.S03.000.A3	1	
	4	KLIKA x2	KKTX0019	338.S04.000.A3	1	Sestava
	5	DVÍŘKA KP21	KKTX0017	054.S05.000.A2	1	Sestava
	6	BOČNICE LEVÁ	PKMBB0188	756.S01.000.A3	1	





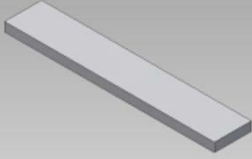
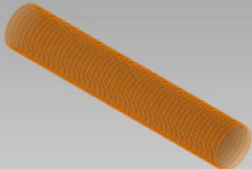

KOTEL KP21	POZICE	POPIS	KÓD	ČÍSLO SOUČÁSTI	POČET KS	POZNÁMKY
	7	BOČNICE PRAVÁ	PKMBB0189	756.S02.000.A3	1	
	8	KRYT JEDNOTKY BOČNÍ	PKMBB0142	726.008.000.A3	1	
	9	DESKA	PKMD0293	756.005.000.A4	1	
	10	KRYT ZADNÍ	PKMBB0202	756.010.000.A2	1	
	11	KRYT HORNÍ	PKMD0091	397.011.000.A3	1	
	12	PANT DVÍŘEK	PKTX0121	054.S05.S03.A4	2	





KOTEL KP21	POZICE	POPIS	KÓD	ČÍSLO SOUČÁSTI	POČET KS	POZNÁMKY
	13	POPELNÍK	PKTX0080	001.013.000.A3	1	
	14	TURBULÁTOR PLOCHÝ 460mm	MRUZ0016	054.016.000.A4	24	
	15	KLÍČ	PKRX0008	286.000.000.A4	8	
	16	ČISTĚNÍ VÝMĚNÍKU KP21	KKTX0053	758.000.000.A3	1	Sestava
	17	DRŽÁK KOTLE	PKRX0006	005.017.000.A3	2	
	19	KERAMIKA NAD DVÍŘKA KP21	MTKE0006	054.021.000.A4	1	

KOTEL KP21	POZICE	POPIS	KÓD	ČÍSLO SOUČÁSTI	POČET KS	POZNÁMKY
	20	DISTANCE	PKMX0037	054.009.003.A4	4	
	22	DRŽÁK SIBRALU	PKMD0095	397.058.000.A4	1	
	23	Hořák KP 51 L TRANS_MK04	KHXX5129	523.V17.000.A3	1	Sestava
	24	REDUKCE	PKRX0022	002.048.000.A4	1	
	25	KRYT	PKMX0201	759.002.000.A3	1	
	26	KERAMIKA TROJÚHELNÍKOVÁ	MTKE0135	420.900.000.A3	3	

KOTEL KP21	POZICE	POPIS	KÓD	ČÍSLO SOUČÁSTI	POČET KS	POZNÁMKY
	27	REFLEKTOR KERAMICKÝ	MTKE0020	001.042.000.A3	1	
	28	ŠKRABKA	PKRX0001	001.S32.000.A4	1	
	37	SIBREX 300 20x80x452	MTIZ0019		1	
	38	HADICE FLEXADUR PU- 1NO DN 80x1000	MRUZ0018		1	
	39	SPONA HADICOVÁ 70-90 NEREZ	MRUZ0089		2	
	40	VENTIL VYPOŠTĚCÍ S PÁČKOU	MRUZ0024		1	

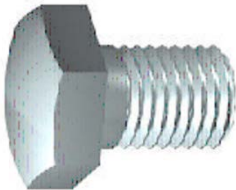
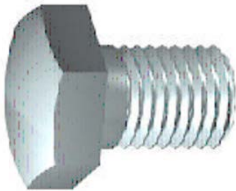



KOTEL KP21	POZICE	POPIS	KÓD	ČÍSLO SOUČÁSTI	POČET KS	POZNÁMKY
	41	Ploché podložky - 10 - 140 HV	MSPX0005	ISO 7089	16	Zn
	42	Šestihránná matice - M8	MSMX0021	DIN 934	4	Zn
	43	Zubová pojistná podložka - A 10,5	MSPX0003	DIN 6797	2	Zn
	44	Šestihránná matice - M10	MSMX0002	DIN 934	10	Zn
	45	Šestihránná matice - M12	MSMX0007	DIN 934	2	Zn
	46	Šrouby samořezné - ST 4,8 x 38 - C - H	MSSX0042	ISO 7049	3	Zn

KOTEL KP21	POZICE	POPIS	KÓD	ČÍSLO SOUČÁSTI	POČET KS	POZNÁMKY
	47	Šestihranný šroub - M8 x 20	MSSX0002	DIN 933	4	Zn
	48	Šestihranný šroub - M8 x 40	MSSX0027	DIN 933	4	Zn
	49	Zubová pojistná podložka - A 4,3	MSPX0010	DIN 6797	4	Zn
	50	Šestihranná matice - M4	MSMX0012	DIN 934	4	Zn
	51	Šrouby samořezné - ST 4,8 x 13 - C - H	MSSX0118	ISO 7049	5	ČERNÝ CHROMÁT
	52	Šestihranná matice - M5	MSMX0017	DIN 934	4	Zn

KOTEL KP21	POZICE	POPIS	KÓD	ČÍSLO SOUČÁSTI	POČET KS	POZNÁMKY
	53	HAVARIJNÍ TERMOSTAT LY 26 I	METRO049		2	
	54	ZÁSLEPKA ČERNÁ 35-38mm	MRUZ0228		1	
	55	ČIDLO KOMÍNOVÉ RJE	PKRX0060		1	
	56	KLÁVESNICE KP X1	METRO116		1	

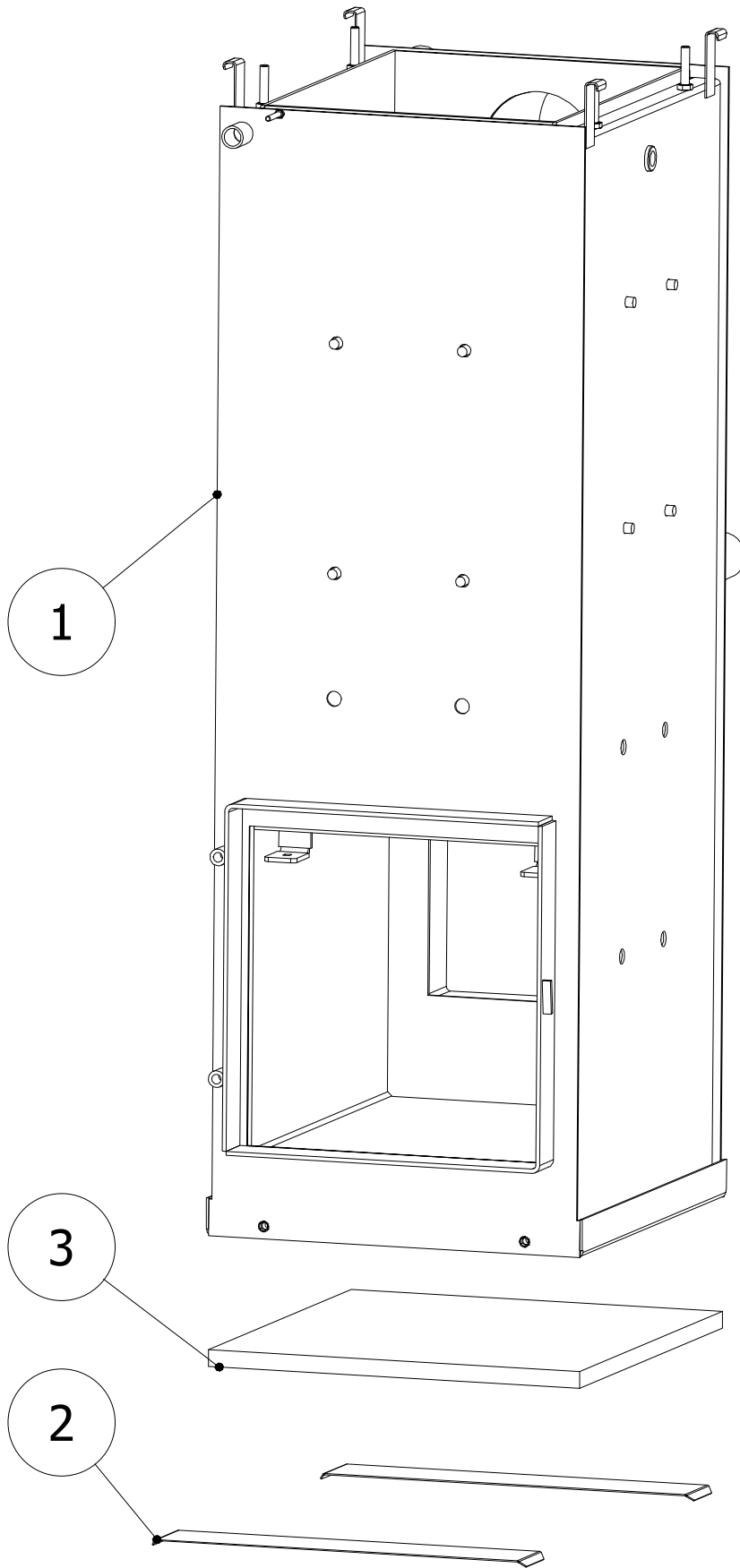

# TĚLESO KOTLOVÉ KP21

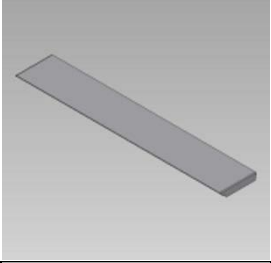
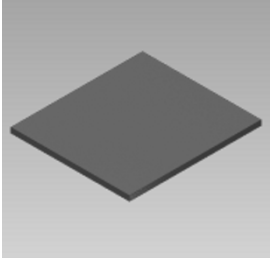

TĚLESO KOTLOVÉ KP21	POZICE	POPIS	KÓD	ČÍSLO SOUČÁSTI	POČET KS	POZNÁMKY
	1	TĚLESO KOTLOVÉ KP21	PKXX2101	054.S01.000.A1	1	
	2	DRŽÁK IZOLACE KP21,KP22	PKTX0347	PKTX0347	2	
	3	IZOLACE 20x515x464	PKTX0343		1	

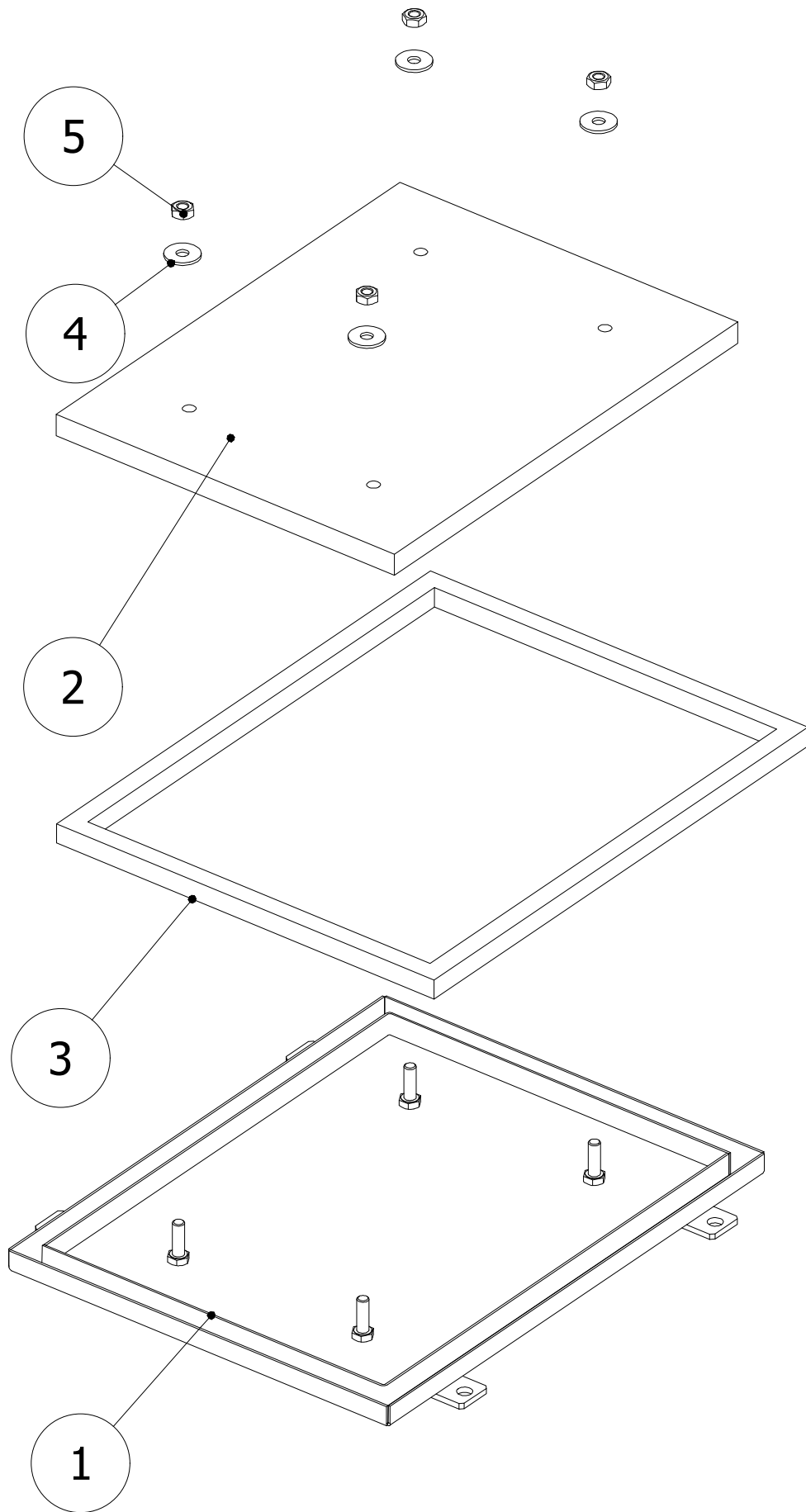
VÍKO

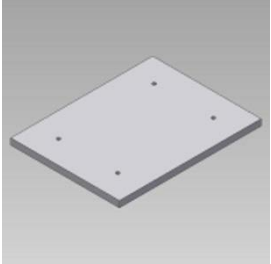
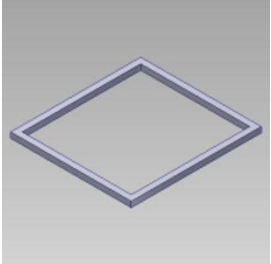

Víko	POZICE	POPIS	KÓD	ČÍSLO SOUČÁSTI	POČET KS	POZNÁMKY
	1	VÍKO KOTL.TĚLESA KP20,21	PKTX0072	001.002.000.A2	1	
	2	SIBREX 140 20x345x446	MTIZ0002		1	
	3	ŠŇŮRA TĚSN. 18x18	MRUZ0133		1.52m	
	4	Podložka - 10,5	MSPX0004	DIN 9021	4	Zn
	5	Šestihránná matice - M10	MSMX0002	DIN 934	4	Zn

KLIKA

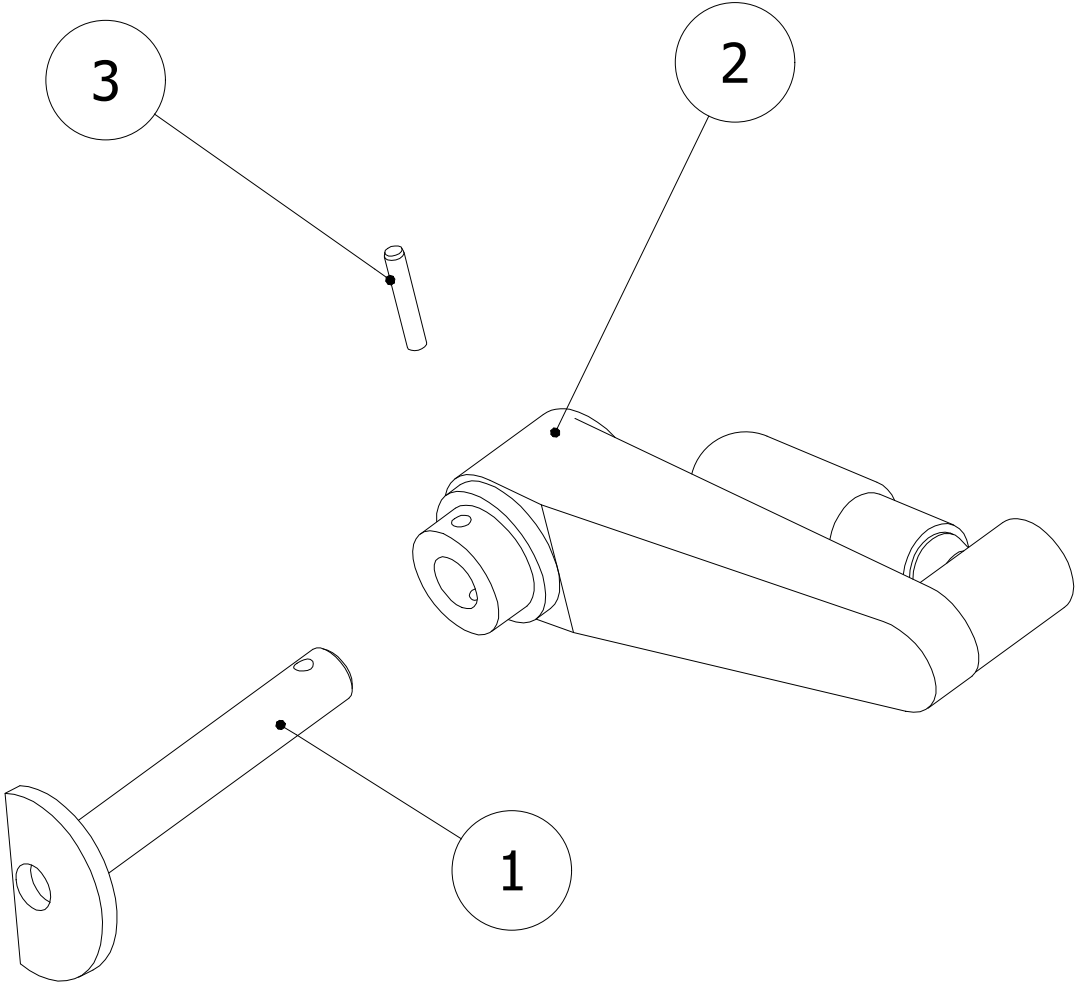



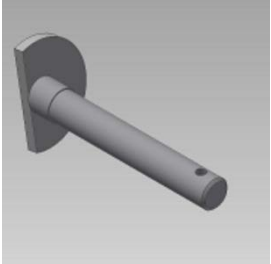

KLIIKA	POZICE	POPIS	KÓD	ČÍSLO SOUČÁSTI	POČET KS	POZNÁMKY
	1	DŘÍK KLIKY	PKTX0118	054.S04.001.A3	1	
	2	KLIIKA SKLAPOVACÍ ELESA GANTER	MRUZ0117	MT.100-AT+IR	1	KÓD 44317
	3	Kolík - 4 x 24 - A (kalený)	MSRX0003	ISO 8734	1	

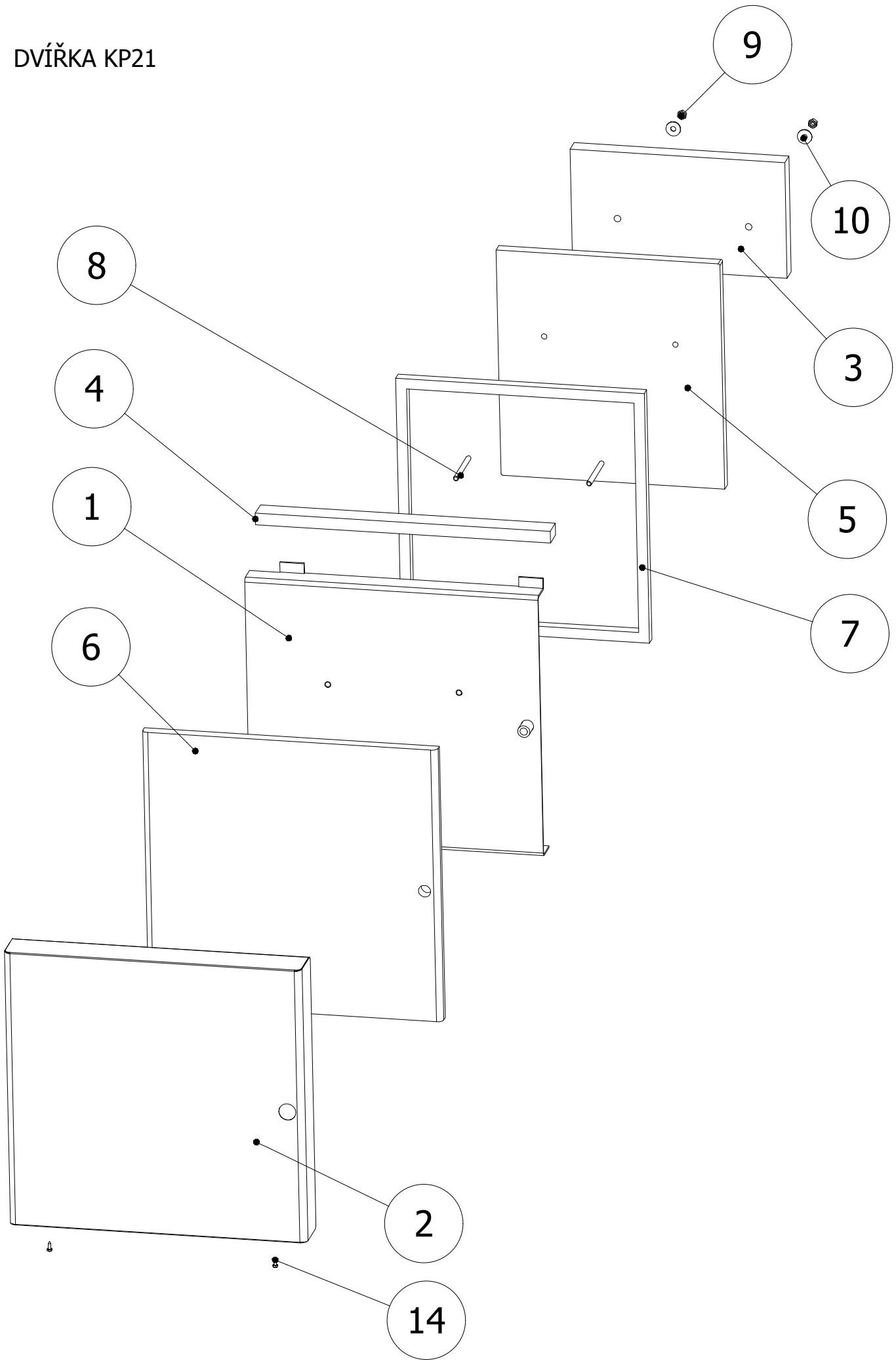
DVÍŘKA KP21



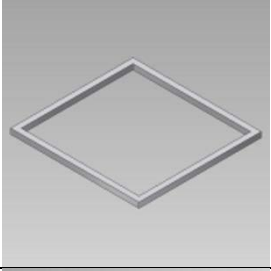
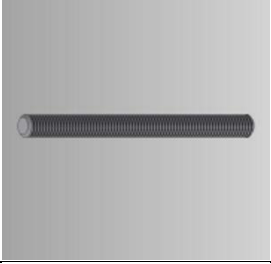

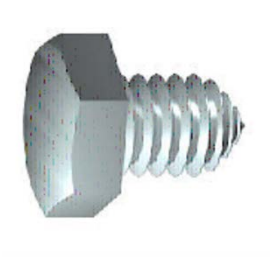
DVÍŘKA KP21	POZICE	POPIS	KÓD	ČÍSLO SOUČÁSTI	POČET KS	POZNÁMKY
	1	DVÍŘKA KP21	PKTX0131	054.005.000.A3	1	
	2	KRYT DVÍŘEK	PKMD0048	054.012.000.A3	1	
	3	KERAMIKA NA DVÍŘKA	MTKE0004	001.005.008.A4	1	
	4	IZOLACE PLÁŠTĚ 20x38x488	MTIZ0011		1	
	5	IZOLACE TĚLA 20x388x370	MTIZ0005		1	
	6	IZOLACE PLÁŠTĚ 20x469x488	MTIZ0011		1	

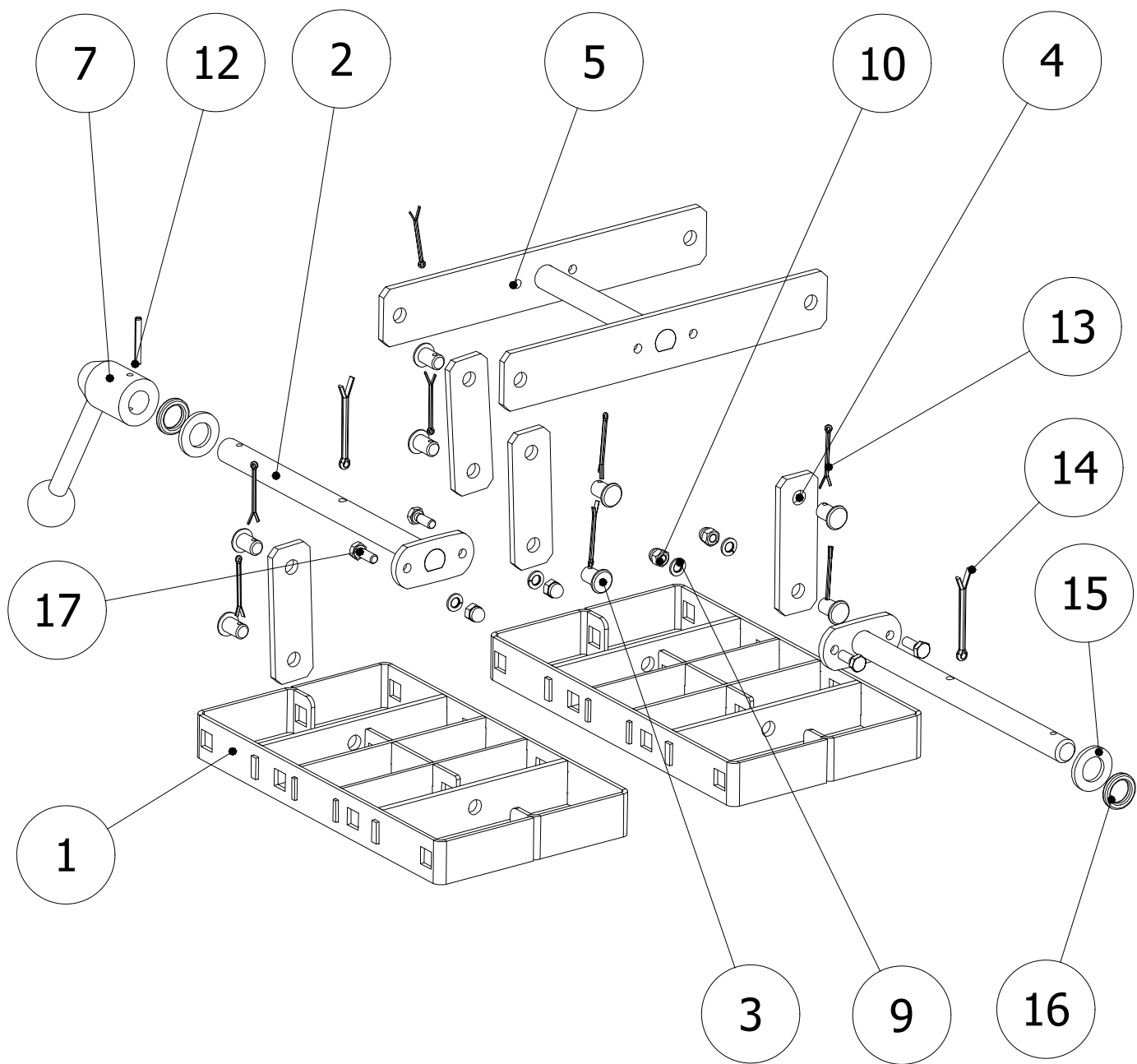

DVÍŘKA KP21	POZICE	POPIS	KÓD	ČÍSLO SOUČÁSTI	POČET KS	POZNÁMKY
	7	TĚSN. ŠŇŮRA 18x18x1620	MRUZ0133		1	
	8	TYČ ZÁVITOVÁ M8x95	PKTX0117		2	Zn
	9	Šestihhraná matice - M8	MSMX0016	DIN 934	2	Zn
	10	Podložka - 8,4	MSPX0008	DIN 9021	2	Zn
	14	Šroub do plechu - ST4,2 x 13	MSSX0012	ISO 1479	2	Zn

# ČISTĚNÍ VÝMĚNÍKU

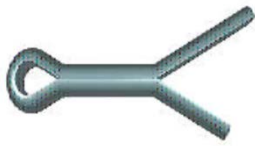
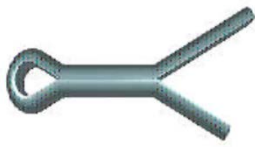
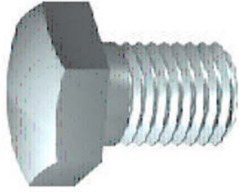

ČISTĚNÍ VÝMĚNÍKU	POZICE	POPIS	KÓD	ČÍSLO SOUČÁSTI	POČET KS	POZNÁMKY
	1	VAHADLO	PKTX0334	758.S01.000.A3	2	
	2	NÁSTAVEC	PKTX0328	758.S06.S00.A4	2	
	3	ČEP	PKTX0053	005.S16.007.A4	8	
	4	ZÁVĚS	PKTX0051	005.S16.004.A4	4	
	5	HŘÍDEL SPOJOVACÍ	PKTX0326	758.S06.A00.A 3	1	
	7	PÁKA UPÍNACÍ	MRUZ0222	GN 212-32- B16-C	1	

ČISTĚNÍ VÝMĚNÍKU	POZICE	POPIS	KÓD	ČÍSLO SOUČÁSTI	POČET KS	POZNÁMKY
	9	Pružná podložka - A6	MSPX0019	DIN 128	4	
	10	Šestihranná matice uzavřená - M6	MSMX0027	DIN 1587	4	
	12	Pružné přímé kolíky - 4 x 30	MSRX0090	ISO 8752	1	
	13	Závlačka - 2,5 x 36	MSRX0048	ISO 1234	8	
	14	Závlačka - 4 x 50	MSRX0021	ISO 1234	2	
	17	Šestihranný šroub - M6 x 16	MSSX0015	DIN 933	4	

ČISTĚNÍ VÝMĚNÍKU	POZICE	POPIS	KÓD	ČÍSLO SOUČÁSTI	POČET KS	POZNÁMKY
	15	Ploché podložky - 16	MSPX0022	ISO 7089	2	
	16	Šňůra těs. čišťení 4x4	PKTX0432		2	



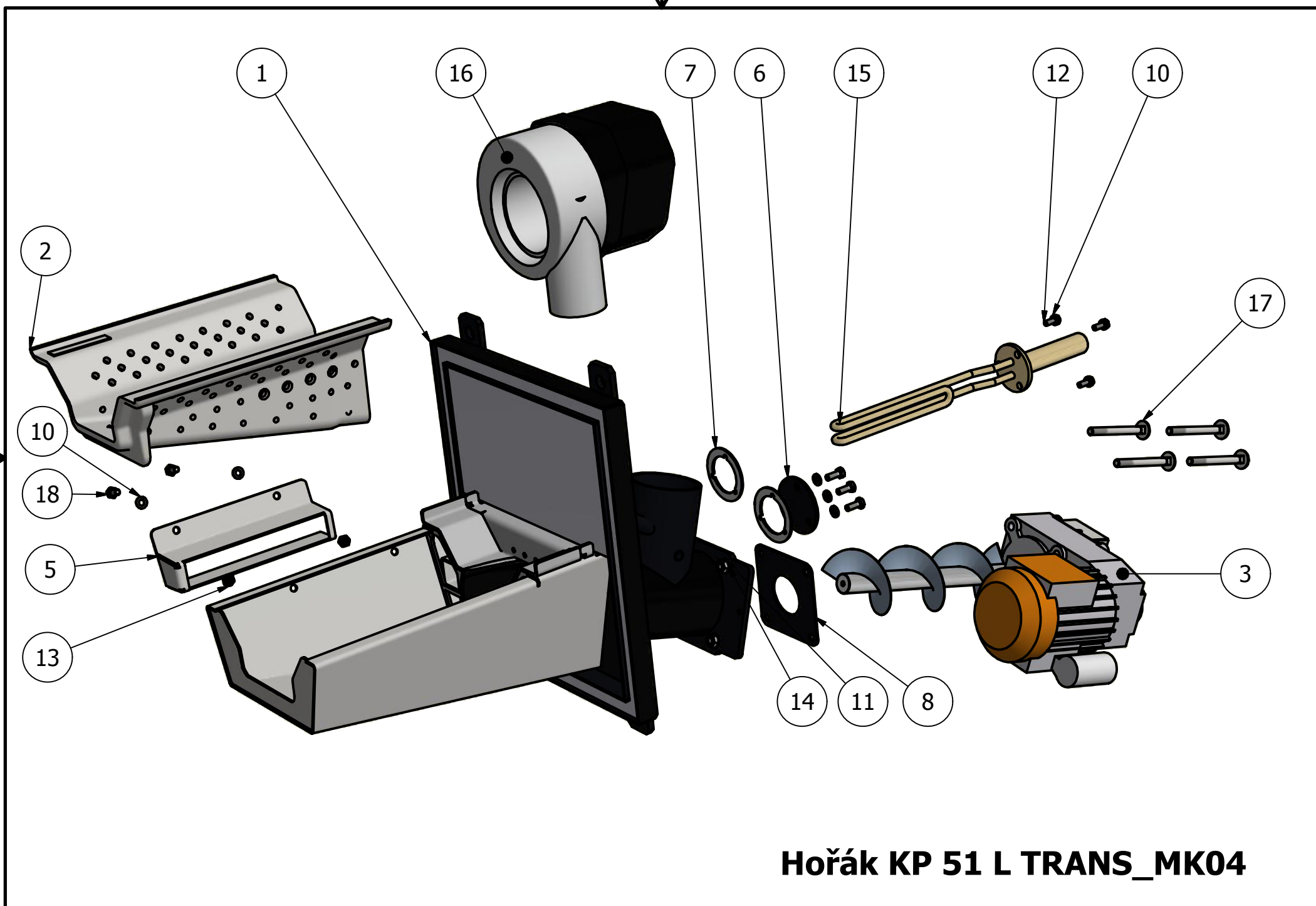

**Hořák KP 51 L TRANS\_MK04**

Hořák KP 51 L TRANS_MK04	POZICE	POPIS	KÓD	ČÍSLO SOUČÁSTI	POZICE KS	POZNÁMKY
	1	HOŘÁK KP51 SVAŘENEC+TĚSNĚNÍ+SIBREX	KHXX5102	523.001.000.A3	1	
	2	DESKA HOŘÁKOVÁ KP51	MHRX0052	523.050.000.A3	1	
	3	Podavač P2 TRANS_MK04+ Canon	KHXX5128	523.S22.000.A3	1	
	5	TUNEL	PHXX0062	523.014.000.A3	1	
	6	VÍČKO	PHXX0113	116.018.000.A4	1	
	7	TĚSNĚNÍ	PHXX0115	493.021.000.A4	2	

Hořák KP 51 L TRANS_MK04	POZICE	POPIS	KÓD	ČÍSLO SOUČÁSTI	POZICE KS	POZNÁMKY
	8	MEZIKUS PRO EPOMOTORY 2013	PHXX0161	428.300.000.A4	1	
	10	Ploché podložky - 6 - 140 HV	MSPX0026	ISO 7089	8	
	11	Ploché podložky - 8 - 140 HV	MSPX0001	ISO 7089	4	
	12	Šestihranný šroub - M6 x 16	MSSX0015	ISO 4017	6	Zn
	13	Šestihranné matice - M6	MSMX0001	ISO 4032	2	
	14	Šestihranné matice - M8	MSMX0016	ISO 4032	4	

Hořák KP 51 L TRANS_MK04	POZICE	POPIS	KÓD	ČÍSLO SOUČÁSTI	POZICE KS	POZNÁMKY
	15	SPIRÁLA ZAPALOVACÍ 1000W ZALOM.	MERX0139		1	
	16	VENTILÁTOR RLG 97	MEVE0005		1	
	17	Šroub s půlk.hl.a 4rh.krčkem - M8 x 100	MSSX0129	DIN 603 - M8 x 100	4	
	18	Šestihranný šroub - M6 x 12	MSSX0083	ISO 4017	2	

# HOŘÁK KP51 SVAŘENEC+TĚSNĚNÍ+SIBREX

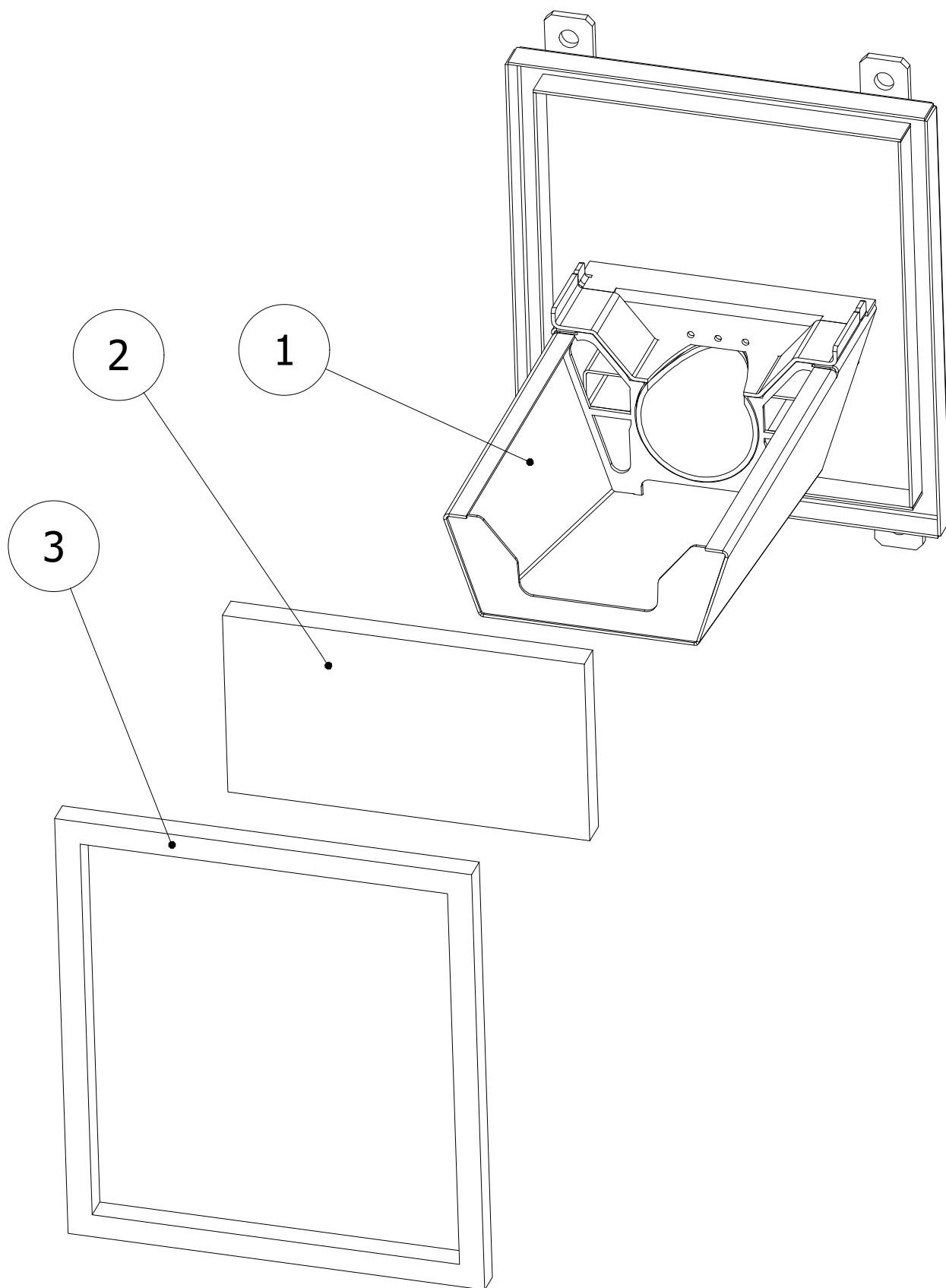

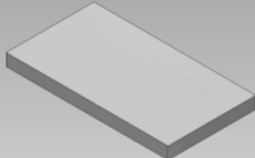
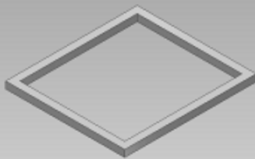
HOŘÁK KP51 SVAŘENEC+TĚSNĚNÍ+SIBREX	POZICE	POPIS	KÓD	ČÍSLO SOUČÁSTI	POZICE KS	POZNÁMKY
	1	HOŘÁK KP51- SVAŘENEC UNI	PHXX5101	523.S00.000.A3	1	
	2	SIBREX 300 20x142x260	MTIZ0003		1	
	3	Šňůra těsnící 18x18	MRUZ0133		1,26m	

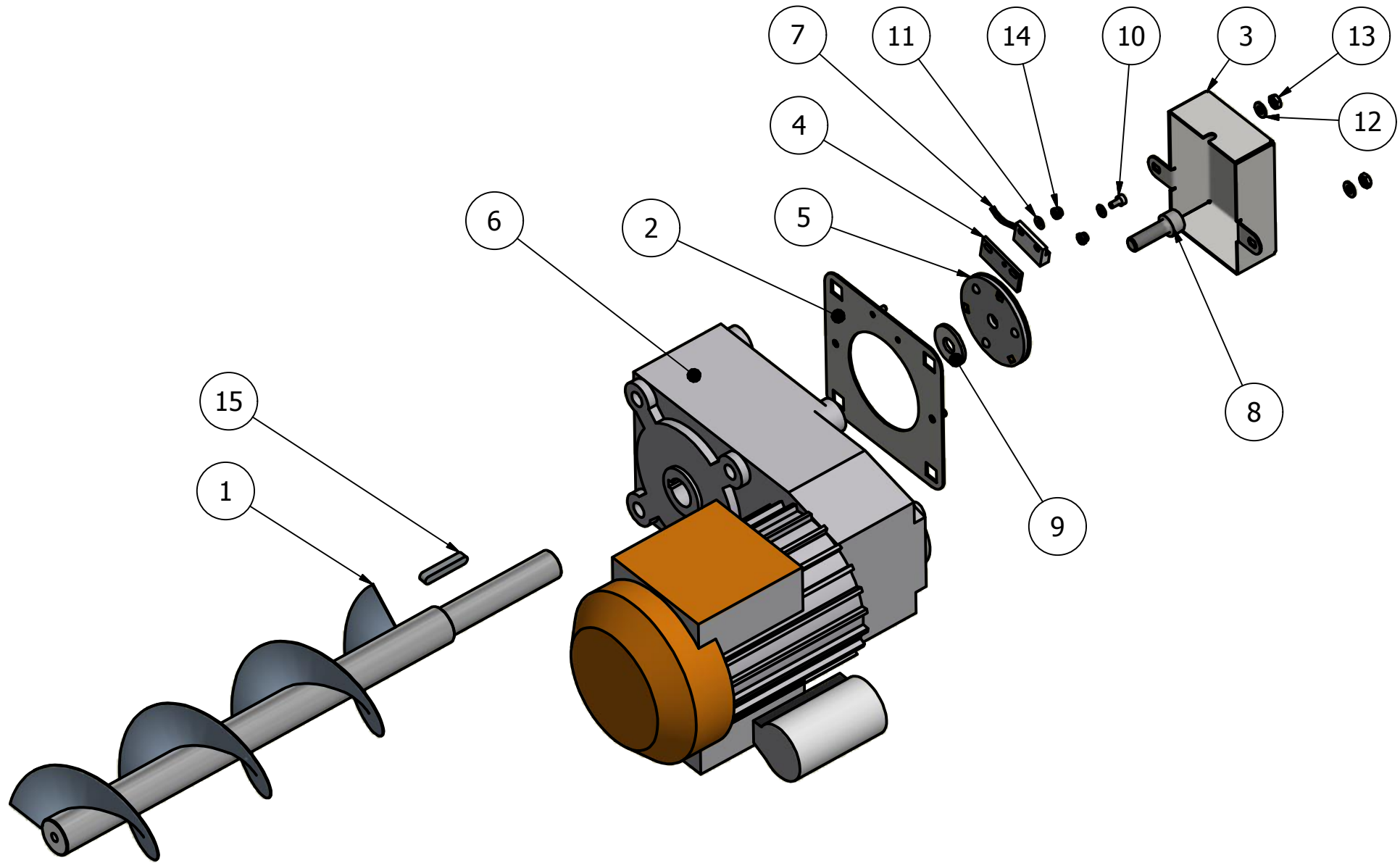



**Podavač P2 TRANS\_MK04 + Canon**

Podavač P2 TRANS_MK04+ Canon	POZICE	POPIS	KÓD	ČÍSLO SOUČÁSTI	POZICE KS	POZNÁMKY
	1	ŠNEK KP51 ABM	PHXX0053	493.S19.000.A3	1	
	2	DRŽÁK SNÍMAČE OTÁČEK	MHVH0119	428.100.000.A4	1	
	3	KRABÍČKA SNÍMAČE SIGMATEK	MHVH0115	786.000.000.A4	1	
	4	Adaptér pro MK04	PHXX0214	798.110.001.A4	1	
	5	KOLO SNÍMAČE MEDER MK04/EPO	PHXX0213	PHXX0213	1	
	6	Motor FT105 U88,9/40W	MEMPO040		1	

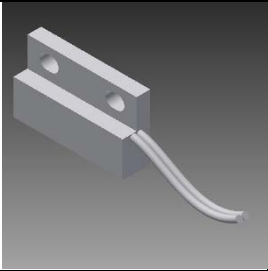
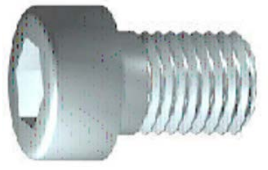
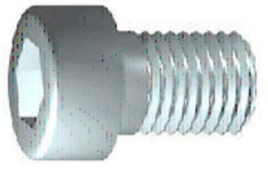

Podavač P2 TRANS_MK04+ Canon	POZICE	POPIS	KÓD	ČÍSLO SOUČÁSTI	POZICE KS	POZNÁMKY
	7	Snímač MEDER MK04 - CANON 9	PKEX0059	Snímač MEDER MK04-CANON 9	1	
	8	Šroub s válc. hl. s vnitř. 6hr. - M8 x 25	MSSX0095	ISO 4762	1	
	9	Ploché podložky - ST 8 - 100 HV	MSPX0008	ISO 7093 C	1	
	10	Šroub s válcovou hlavou - M3 x 6	MSSX0226	DIN 912	1	
	11	Podložky - B 3,2	MSPX0031	CSN 02 1702	2	
	12	Ploché podložky - 4	MSPX0014	ISO 7089	2	

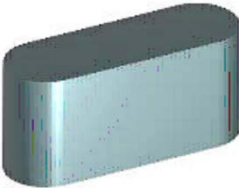
Podavač P2 TRANS_MK04+ Canon	POZICE	POPIS	KÓD	ČÍSLO SOUČÁSTI	POZICE KS	POZNÁMKY
	13	Šestihran- é matice - M4	MSSX0012	ISO 4032	2	
	14	Šestihran- á matice pojistná - M3	MSMX0024	DIN 985	2	
	15	Těsné pero - A 5 x 5 x 30	MSRX0007	DIN 6885	1	

# ELEKTRO

KÓD	POPIS	MNOŽSTVÍ
MERX0003	Objímka plochá BF-F 608P	3,0 ks
MERX0007	Relé VS 116K	1,0 ks
MERX0008	Mústek SP15/Z propojovací	1,0 ks
MERX0010	Pásek vázací 200/2,5	5,0 ks
MERX0013	Relé VS 308K	1,0 ks
MERX0032	Pásek vázací 100/2,5	4,0 ks
MERX0067	Přichytka PKB-BS 27x27mm přírodní samolepící	1,0 ks
MERX0078	Štítek uzemění malý /baleno po 40 ks/	5,0 ks
MERX0220	Lišta TS 35/010	1,0 ks
MERX0223	Páska Izol. 15Mm/10Mpvc bílá	2,0 ks
MERX0645	Svorka PAKL 140 přístr. pr. 1- 4mm	0,2 ks
METR0077	Procesor pro RKP-CPU	1,0 ks
METR0082	Kabel prop. K-PFL-Aud.10	1,0 ks
METR0086	Snímač tepl. TG8-40 KTY 81-220, 0,75m voda	1,0 ks
METR0091	Kabel prop K-PFL20-1500	1,0 ks
METR0094	Vidlice kabel. NAC41S.B černá ENSTO	1,0 ks
METR0103	Vidlice kabel. NBC31S.S modrá ENSTO	2,0 ks
METR0105	Vidlice kabel. NCC31S.P červená ENSTO	1,0 ks
METR0210	Zdroj RKP-PWR Revize R02.1	1,0 ks
MHVR0075	Deska základová Matušík (laser+sloupky)	1,0 ks
MREZ0012	Etiketa stříbrná 210x297 baleno po 20 ks	1,0 ks
MRUZ0021	Štítek logo PONAŠT	1,0 ks
MRUZ0152	Samolepka KP21	1,0 ks
MRUZ0219	Průchodka 24,9 x 1,6 Moss 11214	1,0 ks
MRUZ0272	Zátka antivibrační 1/2 BSP - velikost 8	1,0 ks
MRUZ0274	Zátka souběžná 46.1MM č.465668	2,0 ks
MRUZ0275	Fólie laminovací A4	1,0 ks
MTBX0033	Páska oboustranně lepící š.=15mm	0,25 ks
PKED0033	Kabeláž 11_21_51_2013 PRAVÝ kotel RKP	1,0 ks
PKED0034	Kabely P1,P2,Ventilátor KP 11.21_2013	1,0 ks
PKEX0029	Lišta vkladací 40x40x380 KP 11,21,51	1,0 ks
PKEX0043	Kabeláž zemnicí KP 21	1,0 ks
PKRX0102	Záslepka DIN konektoru	1,0 ks

**PONAST spol. s r.o**  
Na Potůčkách 163  
757 01 Valašské Meziříčí

**ČESKÁ REPUBLIKA**

**[www.ponast.cz](http://www.ponast.cz)**

**tel.: 571 688 111\*, 800 700 068**

**e-mail: [servis@ponast.cz](mailto:servis@ponast.cz)**